

MARINE DISPLAY
MV-xx04, MV-xx05, MV-xx06, MV-xx07

Operating manual

TABLE OF CONTENT

INTRODUCTION	3
1 DESCRIPTION AND OPERATION OF THE PRODUCT	4
1.1 Description	4
1.2 Technical specifications	4
1.3 The Product's structure and operation.....	8
1.4 Measurement tools, instruments and appliances	17
1.5 Marking and sealing	17
1.6 Packaging	17
2 INTENDED USE.....	18
2.1 Operational constraints.....	18
2.2 Preparation for the Product's operation	18
2.3 Usage of the Product	19
3 TECHNICAL SERVICE OF THE PRODUCT.....	20
3.1 General instructions.....	20
3.2 Safety features	20
3.3 Maintenance routine	20
3.4 Preservation	21
4 INSTALLATION AND DISASSEMBLY ON THE PRODUCT	22
4.1 General description.....	22
4.2 Safety features	22
4.3 Current repair.....	22
5 STORAGE.....	24
6 TRANSPORTATION.....	25
7 DISPOSAL.....	26
8 WARRANTY.....	27
ANNEX A DESCRIPTION OF THE PRODUCT'S MENU	28

INTRODUCTION

This operating manual (hereinafter referred to as the OM) covers structure, construction, specifications of Marine display type MV-xx04, MV-xx05, MV-xx06, MV-xx07 (hereinafter referred to as the Product), its components and instructions required for the device's correct and safe operation (intended use, technical service (hereinafter – the TS), current repair), as well as disposal information for its components.

Only those who have read operational documentation shall be permitted to operate with the Product.

Only those who have had general education in the area of electronic devices and read operational documentation shall be permitted to provide the Product's service.

1 DESCRIPTION AND OPERATION OF THE PRODUCT

1.1 DESCRIPTION

The Product is a multipurpose device which displays textual, graphic and other data as a component of navigation and automation systems, security video surveillance, etc.

1.2 TECHNICAL SPECIFICATIONS

1.2.1 The Product ensures:

- reception of digital or analog video signal and its graphic output on the display;
- operation with AC mains 50/60 Hz and rated voltage 110 V or 220 V, or DC mains with rated voltage 12 V or 24 V;
- screen surface protection;
- dimming (adjustment) of backlight brightness from the front panel within the range 0 % – 100 % (for designs MV-1005, MV-1007 within the range 5 % – 100 %);
- installation of protective glass on the screen surface with anti-glare coating.

The Product optionally ensures:

- the Product may optionally be used as a input device with touch capacitive panel;
- dimming (adjustment) of backlight brightness remotely (using digital interface).

1.2.2 Main parameters and technical specifications of the Product are represented in Tables 1 – 4.

Note – Products of MV-xx06 and MV-xx07 types have a matrix with increased brightness.

Table 1 – Technical specifications of the MV-xx04

Parameter	MV-1204	MV-1504	MV-1704	MV-1904	MV-2104	
	Value					
Screen diagonal *	12.1"	15"	17"	19"	21.3"	
Screen format	4:3		5:4		4:3	
Screen resolution	1024 x 768		1280 x 1024		1600 x 1200	
Viewable area, mm	246 x 184	304 x 228	337 x 270	376 x 301	432 x 324	
Brightness, cd/m ² ***	standard	250 to 500				
	increased	from 500				
Viewing angle **** (vertically / horizontally)	standard brightness	160°/160°	150°/160°	160°/170°	178°/178°	178°/178°
	increased brightness	160°/160°	150°/160°	140°/160°	178°/178°	178°/178°
Contrast ratio	standard brightness	from 700:1	from 800:1	from 1000:1		from 1400:1
	increased brightness	from 700:1			from 1000:1	
Screen surface	anti-glare glass or touch screen (option)					
Speakers	no		yes			
Supported interfaces	VGA, DVI, HDMI or VGA, DVI, HDMI, DP					
Supply voltage **	220 VAC, 110 VAC, 24 VDC, 12 VDC					
Protection degree	IP22 or IP56 (option) – front side, IP22 – other surfaces					
Type of connectors (one of available options)	standard or protected					
Operating temperature, °C	-15 to +55					
Limiting temperature, °C	-60 to +70					
* The monoblocks may be delivered with non-standard diagonals.						
** One of available options.						
*** Given brightness can differ depending on the order.						
**** Viewing angles are relative to the centre point of the screen.						

Table 2 – Technical specifications of the MV-xx05

Parameter	MV-1005	MV-2105	MV-2305	MV-2405	MV-2705	MV-3205	MV-4205	MV-4605
	Value							
Screen diagonal *	10.1"	21.5"	23"	24"	27"	31.5"	42"	46"
Screen format	16:10	16:9		16:10	16:9			
Screen resolution	1280 x 800	1920 x 1080		1920 x 1200	1920 x 1080			
Viewable area, mm	217x136	476x268	509x286	518x324	597x336	698x392	930x523	1018x572
Brightness, cd/m ² ***	standard	250 to 500		from 300	250 to 500		250 to 700	
	increased	from 500		from 300	from 500		from 750	
Viewing angle **** (vertically / horizontally)	standard brightness	170°/170°	178°/178°					
	increased brightness	170°/170°	178°/178°					
Contrast ratio	standard brightness	from 1300:1	from 5000:1	from 1000:1		from 3000:1	from 4000:1	
	increased brightness	from 1300:1	from 1000:1					
Screen surface	touch screen	anti-glare glass or touch screen (option)						
Speakers	yes							
Supported interfaces	VGA, DVI, HDMI or VGA, DVI, HDMI, DP							
Supply voltage **	220 VAC, 110 VAC, 24 VDC, 12 VDC					220 VAC, 110 VAC, 24 VDC		
Protection degree	IP22 or IP56 (option) – front side, IP22 – other surfaces							
Type of connectors (one of available options)	standard or protected							
Operating temperature, °C	-15 to +55							
Limiting temperature, °C	-60 to +70							
* The monoblocks may be delivered with non-standard diagonals.								
** One of available options.								
*** Given brightness can differ depending on the order.								
**** Viewing angles are relative to the centre point of the screen.								

Table 3 – Technical specifications of the MV-xx06

Parameter	MV-1206	MV-1506	MV-1706	MV-1906	MV-2106
	Value				
Screen diagonal *	12.1"	15"	17"	19"	21.3"
Screen format	4:3		5:4		4:3
Screen resolution	1024 x 768		1280 x 1024		1600 x 1200
Viewable area, mm	246 x 184	304 x 228	337 x 270	376 x 301	432 x 324
Brightness, cd/m ² ***	from 500				
Viewing angle **** (vertically / horizontally)	160°/160°	150°/160°	140°/160°	178°/178°	178°/178°
Contrast ratio	from 700:1			from 1000:1	
Screen surface	anti-glare glass or anti-glare glass with touch screen (option)				
Speakers	no		yes		
Supported interfaces	VGA, DVI, HDMI or VGA, DVI, HDMI, DP				
Supply voltage **	220 VAC, 110 VAC, 24 VDC, 12 VDC				
Protection degree	IP22 or IP56 (option) – front side, IP22 – other surfaces				
Type of connectors (one of available options)	standard or protected				
Operating temperature, °C	-15 to +55				
Limiting temperature, °C	-60 to +70				
* The monoblocks may be delivered with non-standard diagonals.					
** One of available options.					
*** Given brightness can differ depending on the order.					
**** Viewing angles are relative to the centre point of the screen.					

Table 4 – Technical specifications of the MV-xx07

Parameter	MV-1007	MV-2107	MV-2307	MV-2407	MV-2707	MV-3207	MV-4207	MV-4607
	Value							
Screen diagonal *	10.1"	21.5"	23"	24"	27"	31.5"	42"	46"
Screen format	16:10	16:9		16:10	16:9			
Screen resolution	1280 x 800	1920 x 1080		1920 x 1200	1920 x 1080			
Viewable area, mm	217x136	476x268	509x286	518x324	597x336	698x392	930x523	1018x572
Brightness, cd/m ² ***	from 500		from 300	from 1200	from 500	from 700		
Viewing angle **** (vertically / horizontally)	170°/170°	178°/178°						
Contrast ratio	from 1300:1	from 1000:1						
Screen surface	anti-glare glass or anti-glare glass with touch screen (option)							
Speakers	yes							
Supported interfaces	VGA, DVI, HDMI or VGA, DVI, HDMI, DP							
Supply voltage **	220 VAC, 110 VAC, 24 VDC, 12 VDC					220 VAC, 110 VAC, 24 VDC		
Protection degree	IP22 or IP56 (option) – front side, IP22 – other surfaces							
Type of connectors (one out of available options)	standard or protected							
Operating temperature, °C	-15 to +55							
Limiting temperature, °C	-60 to +70							
* The monoblocks may be delivered with non-standard diagonals.								
** One of available options.								
*** Given brightness can differ depending on the order.								
**** Viewing angles are relative to the centre point of the screen.								

1.2.3 Products’ overall dimensions depending on the diagonal are represented in Figures 1 and 2.

Notes

1 Figures 1 and 2 show overall dimensions of the Products’ casings not including a set of mounting brackets.

2 Product’s overall dimensions in Figures 1 and 2 are informative and may differ from particular Product design depending on the order. Inquire the manufacturer for overall dimensions of particular Product design.

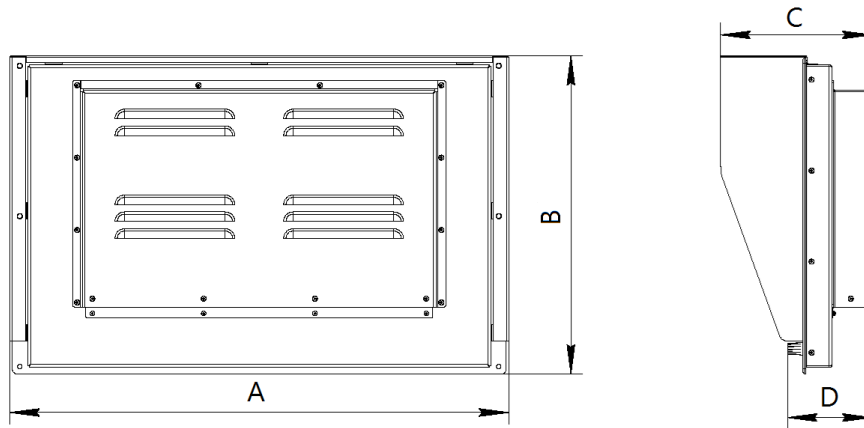

Design	A, mm	B, mm	C, mm	D, mm
MV-1005	285.0	238.0	153.5	97.0
MV-1204	327.0	263.0	146.5	87.0
MV-1504	384.5	314.0	181.0	100.5
MV-1704	417.5	360.0	183.0	102.5
MV-1904	455.0	389.0	183.0	103.5
MV-2104	514.5	413.0	193.0	113.5

Design	A, mm	B, mm	C, mm	D, mm
MV-2105	554.0	359.0	187.5	108.0
MV-2305	591.5	378.0	181.0	101.5
MV-2405	603.5	418.0	188.5	109.0
MV-2705	674.0	424.0	188.5	98.0
MV-3205	811.0	542.0	213.0	123.5
MV-4205	1051.0	675.0	262.0	122.5
MV-4605	1144.5	727.5	261.0	121.5

Figure 1 – Overall dimensions of the Products MV-xx04, MV-xx05 type

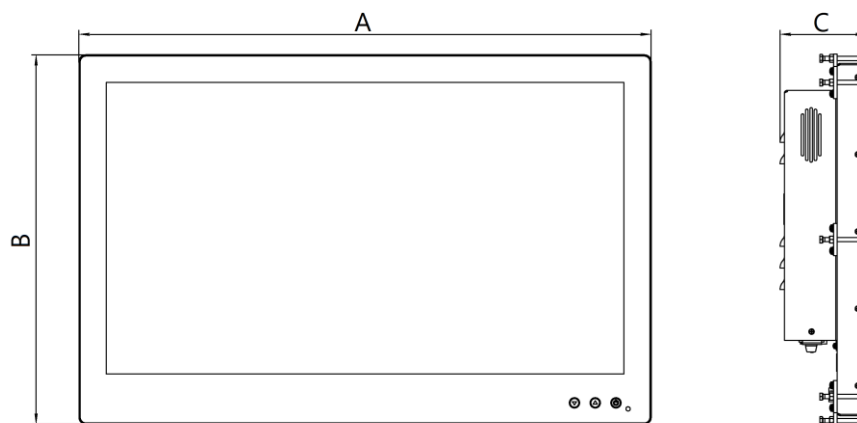

Design	A, mm	B, mm	C, mm
MV-1007	260.0	198.0	102.5
MV-1206	302.5	251.0	100.0
MV-1506	362.0	302.0	103.0
MV-1706	395.0	348.0	105.5
MV-1906	430.5	375.5	103.0
MV-2106	492.0	401.0	109.0

Design	A, mm	B, mm	C, mm
MV-2107	529.5	347.5	93.5
MV-2307	567.5	364.5	102.0
MV-2407	590.0	419.5	108.5
MV-2707	662.0	426.5	100.0
MV-3207	759.0	478.0	102.0
MV-4207	1000.0	611.0	112.0
MV-4607	1092.5	663.5	112.0

Figure 2 – Overall dimensions of the Products MV-xx06, MV-xx07 type

1.3 THE PRODUCT'S STRUCTURE AND OPERATION

1.3.1 Installation

The Product enables different types of mounting depending on the order. For all types of mounting a sunshield is mounted using screws delivered in the mounting kit. For desk-top or wall mounting of the Products with the diagonal more than 21" vibration isolators are provided. Types of mounting are shown in Figures 3 – 7.

Caution! Provide 160 mm free space from the detachable connection to connect the Product at mounting.

Note – Depending on the diagonal of the product, the mounting parts may differ.

1) Panel mounting with outer fastenings (see Figure 3) is the fastening of the product from the inner surface of the remote control using plates, brackets and an installation kit of hardware.

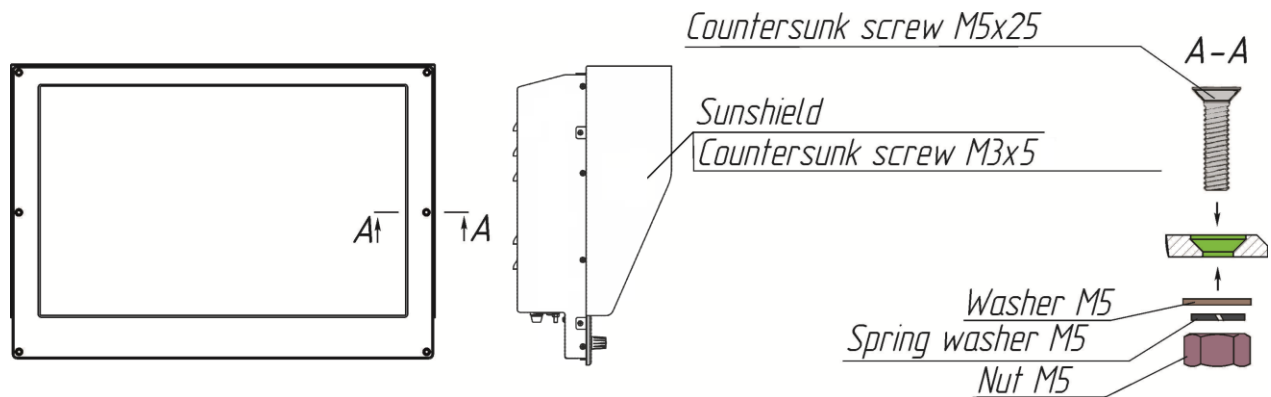

Figure 3 – Panel mounting with outer fastenings

2) Panel mounting with inner fastenings (see Figure 4) ensures fastening from the inner panel of console using plates and a mounting kit of metal ware.

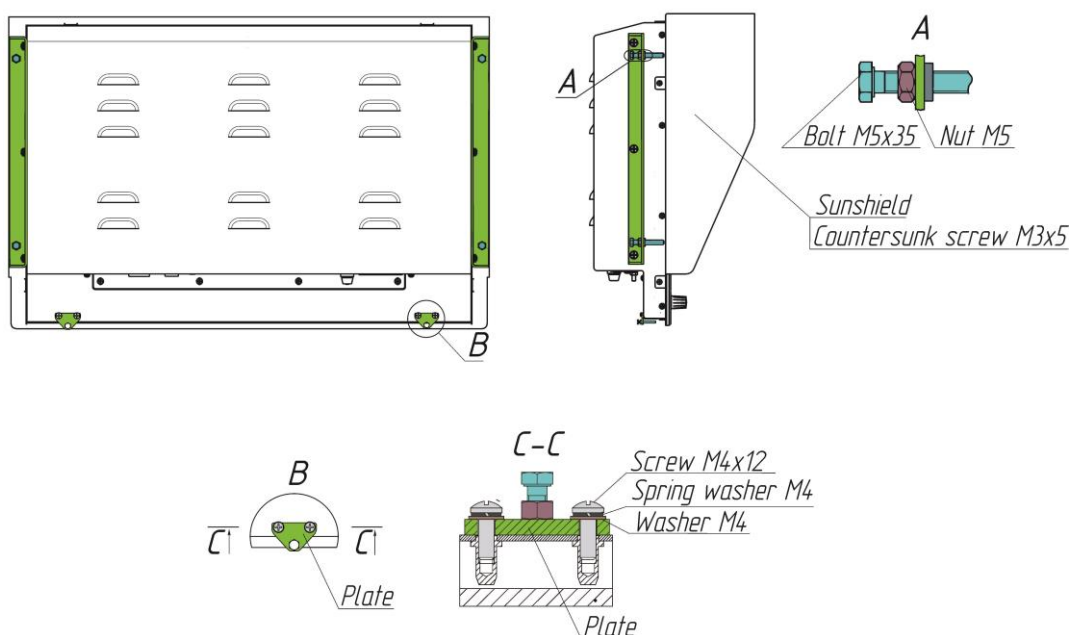

Figure 4 – Panel mounting with inner fastenings

3) Desk-top mounting with an adjustable bracket (see Figure 5) ensures mounting on a surface using adjustable brackets, nut handles and a mounting kit of metal ware.

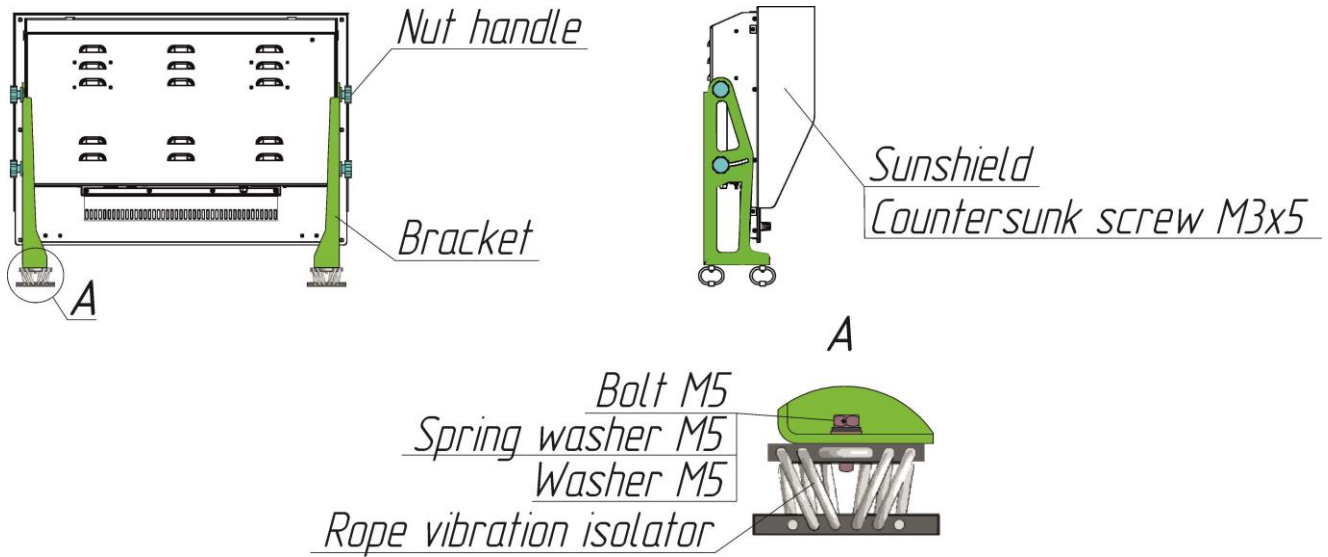

Figure 5 – Desk-top mounting with an adjustable bracket

4) Wall mounting with an adjustable bracket (see Figure Figure 6) ensures mounting on a surface using adjustable brackets, nut handles and a mounting kit of metal ware.

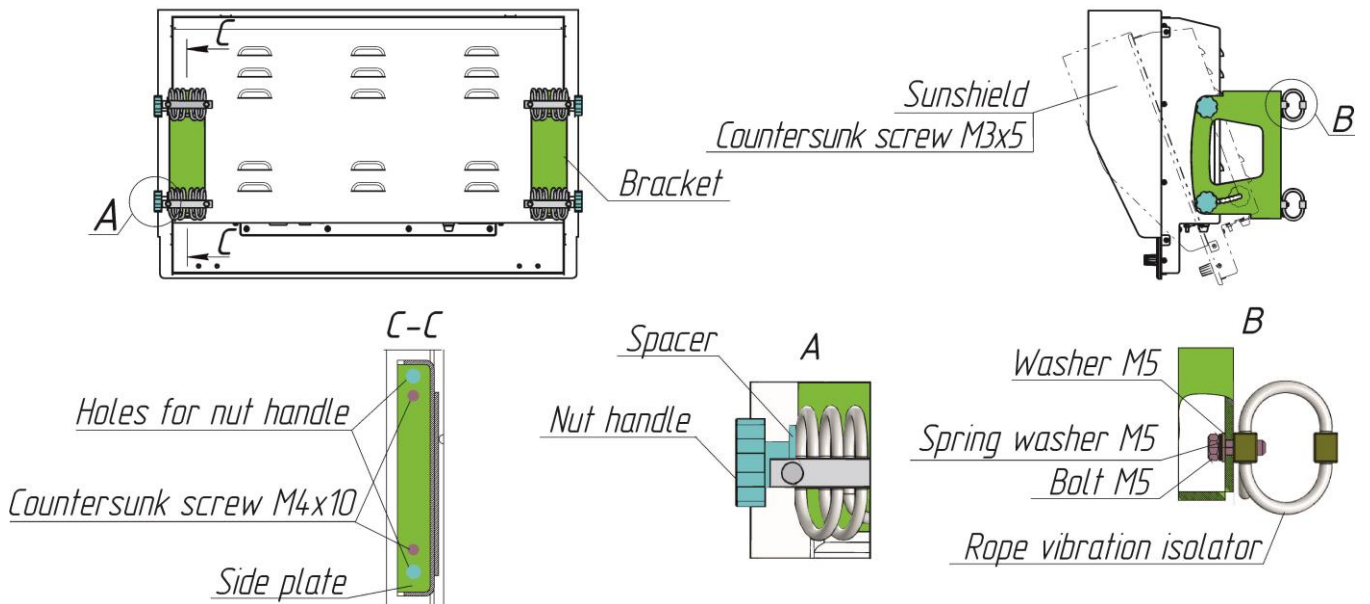

Figure 6 – Wall mounting with an adjustable bracket

6) Wall mounting with a non-adjustable bracket (see Figure 7) ensures mounting on a surface using brackets and a mounting kit of metal ware.

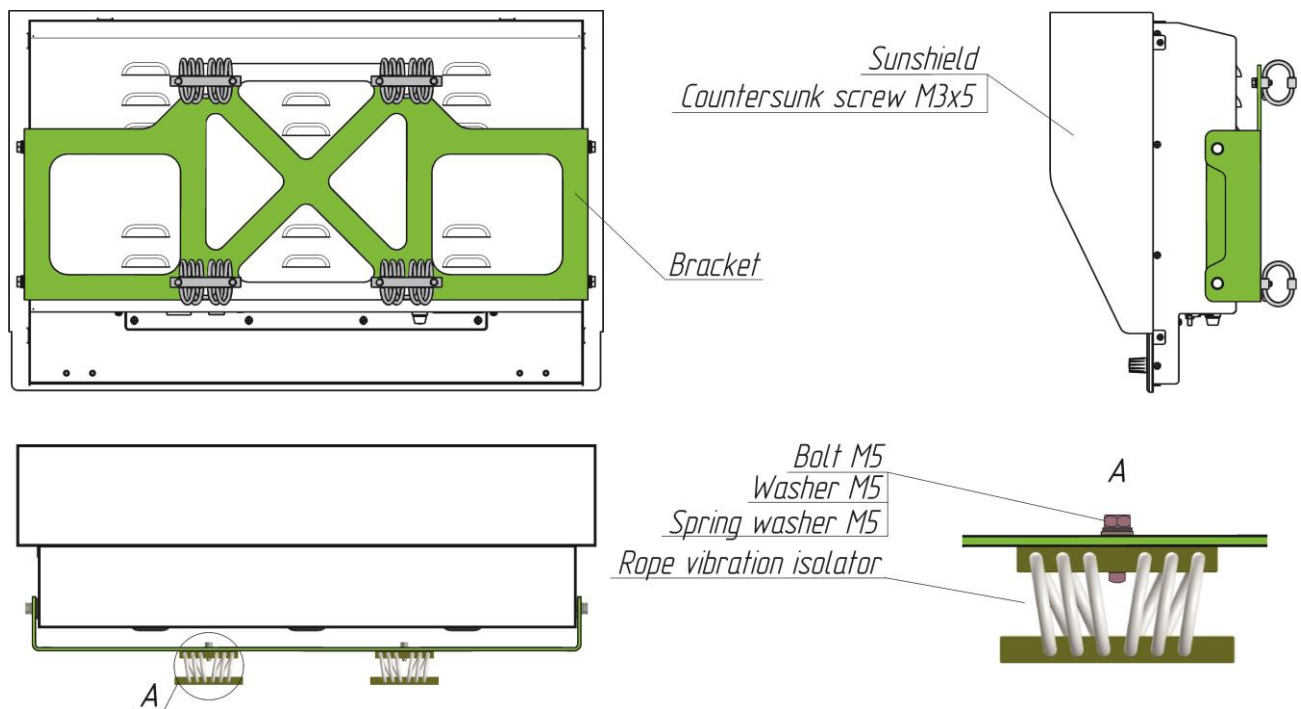

Figure 7 – Wall mounting

1.3.2 General description

The Product is manufactured in metal casing, where a power connector, audio port and video ports are generally located. Connectors for touch screen or remote brightness control can be optionally added to the Product. Additional connectors can be provided to connect a touch screen or remote brightness control. Connectors are made in standard version, see Figure 8 (the actual presence and location of the product connectors may differ from that shown).

For the description of connectors, see Table 5. Electrical connectors pinouts are represented in Tables 6–15.

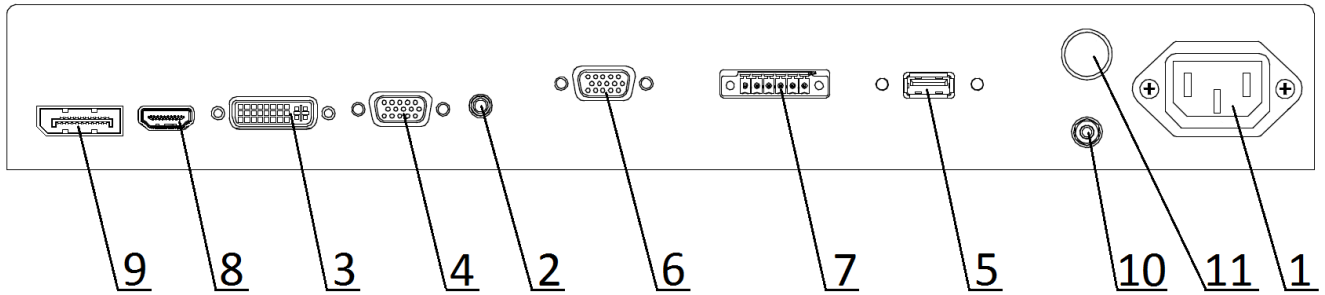

Figure 8 – Product connector layout

Table 5 – Description of the Product’s connectors

N.	Name	Description	Type
1	XPn.8	To connect AC voltage 220 V, 50 Hz	C13
	XPn.9	To connect AC voltage 110 V, 50 Hz	C13
	XSn.10	To connect DC voltage 24 V	C14
	XSn.11	To connect DC voltage 12 V	C14
2	XSn.12	To connect common audio	3.5 jack
3	XSn.2	To connect DVI-D source	DVI-D
	XSn.3	To connect DVI-I source	DVI-I
4	XSn.1	To connect VGA	DB-15F
5	XSn.25	To connect to USB port a touch screen or USB devices	USB type A
6	XPn.20	To connect touch screen RS-232	DB-9M
7	XSn.20	Remote brightness control	BCH-350HF-6 GY
8	XSn.4	To connect HDMI source	HDMI
9	XSn.5	To connect DP source	DP
10	–	Grounding stud	–
11	–	Fuse holder	–

Note – n - ordinal number of same-type connectors. For example, if the device has 2 USB interfaces, they are marked as: XS1.25, XS2.25.

Table 6 – Description of XPn.8, XPn.9 connector pins

Type	Pin №	Description
 (view from soldering side)	1	L
	⊥	E (PE)
	2	N

Table 7 – Description of XSn.10, XSn.11 connector pins

Type	Pin №	Description
 (view from soldering side)	⊥	E (PE)
	1	+ 24 V
	2	0 V

Table 8 – Description of XSn.12 connector pins

Type	Pin №	Description
	1	Common (GND)
	2	Lin. right (Line_R)
	3	Lin.left (Line_L)

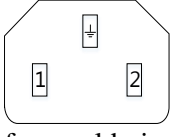
Table 9 – Description of XSn.1 connector pins

Type	Pin №	Description
 <p>(pinout of unit from side of cable connection)</p>	1	Red
	2	Green
	3	Blue
	4	Not used
	5	common (GND)
	6	GND_Red
	7	GND_Green
	8	GND_Blue
	9	+ 5 V
	10	GND
	11	GND
	12	data (SDA)
	13	HSYNC
	14	VSYNC
	15	Data sync (SCL)

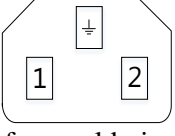
Table 10 – Description of XPn.20 connector pins

Type	Pin №	Description
 <p>(view from soldering side)</p>	1	–
	2	RxD
	3	TxD
	4	–
	5	GND
	6	–
	7	RTS
	8	CTS
	9	–

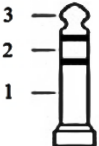
Table 11 – Description of XSn.25 connector pins

Type	Pin №	Description
 <p>(view from connection side)</p>	1	+ 5 V (VCC)
	2	data – (D –)
	3	data + (D +)
	4	GND

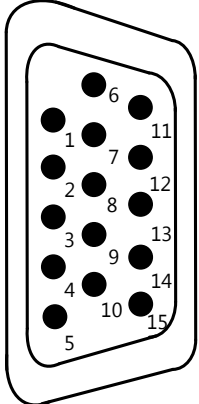
Table 12 – Description of XSn.2, XSn.3 connector pins

Type	Pin № DVI-D	Pin № DVI-I	Description
 <p>(pinout of unit from side of cable connection)</p>	1	1	TMDS 2 -
	2	2	TMDS 2 +
	3	3	TMDS 2 Sh
	4	4	Not used
	5	5	Not used
	6	6	SCL
	7	7	SDA
	8	8	Not used
	9	9	TMDS 1 -
	10	10	TMDS 1 +
	11	11	TMDS 1 Sh
	12	12	Not used
	13	13	Not used
	14	14	+ 5 V
	15	15	GND
	16	16	HPD
	17	17	TMDS 0 -
	18	18	TMDS 0 +
	19	19	TMDS 0 Sh
	20	20	Not used
	21	21	Not used
	22	22	TMDS Cl Sh
	23	23	TMDS Cl +
	24	24	TMDS Cl -
	-	C1	Analog RED
	-	C2	Analog GREEN
-	C3	Analog BLUE	
-	C4	Analog HORZ SYNC	
-	C5	Analog GROUND	

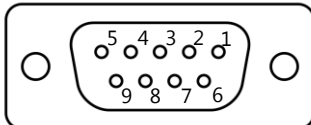
Table 13 – Description of XSn.17 connector pins

Type	Pin №	Description
 <p>(pinout of unit from side of cable connection)</p>	1	TMDS 2 +
	2	TMDS 2 Sh
	3	TMDS 2 -
	4	TMDS 1 +
	5	TMDS 1 Sh
	6	TMDS 1 -
	7	TMDS 0 +
	8	TMDS 0 Sh
	9	TMDS 0 -
	10	TMDS Cl +
	11	TMDS Cl Sh
	12	TMDS Cl -
	13	CEC
	14	Not used
	15	SCL
	16	SDA
	17	GND
	18	+ 5 V
	19	HPD

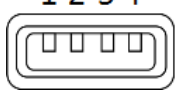
Table 14 – Description of XSn.5 connector pins

Type	Pin №	Description
 <p>(pinout of unit from side of cable connection)</p>	1	Main Link Lane 0 +
	2	GND
	3	Main Link Lane 0 –
	4	Main Link Lane 1+
	5	GND
	6	Main Link Lane 1 –
	7	Main Link Lane 2 +
	8	GND
	9	Main Link Lane 2 –
	10	Main Link Lane 3 +
	11	GND
	12	Main Link Lane 3 –
	13	Configuration 1
	14	Configuration 2
	15	Auxiliary Channel +
	16	GND
	17	Auxiliary Channel –
	18	Hot Plug Detect
	19	Return
	20	DP_PWR

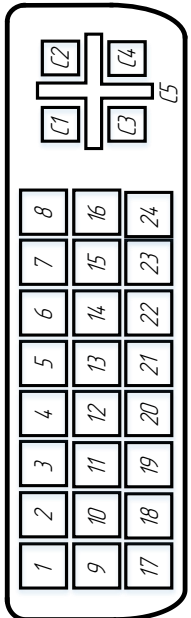
Table 15 – Description of XSn.20 connector pins

Type	Pin №	Description
	1	Tx
	2	Rx
	3	–
	4	–
	5	GNDi
	6	GND

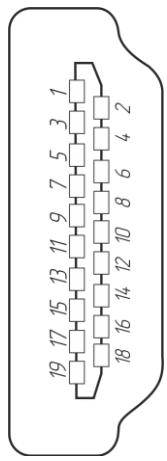
1.3.3 Controls and indication of MV-xx04, MV-xx05 type

Colour display with a diagonal in compliance with Tables 1–2 is located on the front panel of the Products MV-xx04, MV-x05 type. The Product may be delivered in two designs: anti-glare glass or touch capacitive panel with control signal of sensor RS-232 or USB.

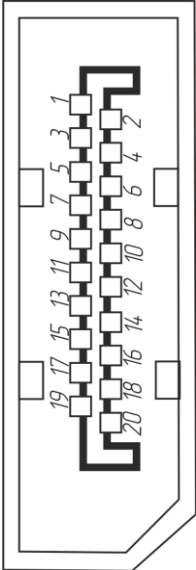
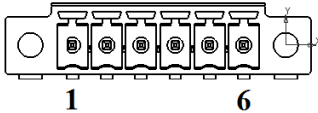
Controls, indication (LEDs) and speakers are also located on the front panel, see Figure 9 (the Product's appearance may be different and depends on order). Description of the controls and indication (LEDs) are represented in Table 16.

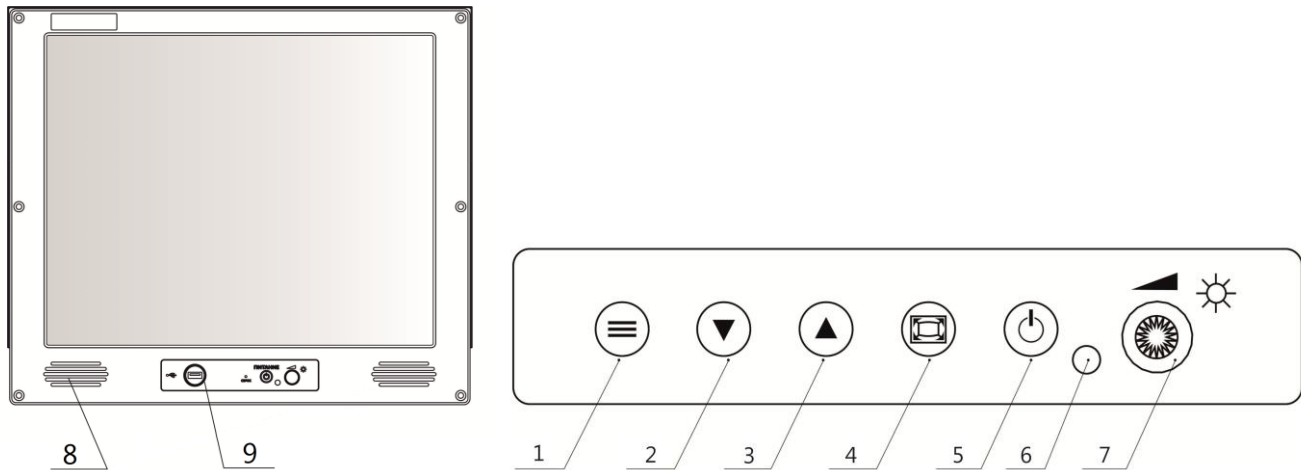

Figure 9 – Layout of controls, indication (LEDs) and speakers on the front panel of the Products MV-xx04, MV-xx05 type

Table 16 – Control and indication description

N	Name	Description
1	“Menu” button	To access the settings menu; To exit the settings menu; To exit the selected parameter
		To access the settings menu; To select a parameter in the settings menu (depending on the software version)
2	“▼”	If menu is inactive – acts as switching between channels;
3	“▲”	If menu is active – navigate through the menu and select parameters
4	Button “Automatic adjustment – Select”	If menu is inactive – automatic adjustment of the picture or switchover of video signal (VGA or DVI/HDMI);
		If menu is active – selects menu item or exits the menu and cancels the last selected parameter in the settings menu (depending on the software version)
5	“Power” button	To switch the Product on / off
6	Brightness LED	Screen brightness level is changed synchronously with the backlight level
7	Brightness dimmer	To increase – decrease screen brightness;
		Extreme right position – max. level of backlight;
		Extreme left position – no backlight
8	–	Speakers
9	–	Control and indication panel

1.3.4 Controls and indication (LEDs) of the Products MV-xx06, MV-xx07 type

Colour display with a diagonal in compliance with Tables 3 and 4 is located on the front panel of the Products MV-xx06, MV-x07 type. The Product may be delivered in two designs: anti-glare glass or touch capacitive panel with control signal of sensor RS-232 or USB.

Touch buttons with blue backlight are also located on the front panel, see Figure 10 (the Product's appearance may be different and depends on order). Speakers, if any exist, are located on the back panel of the Product Description of the controls and indication (LEDs) 17 see in Table 17.

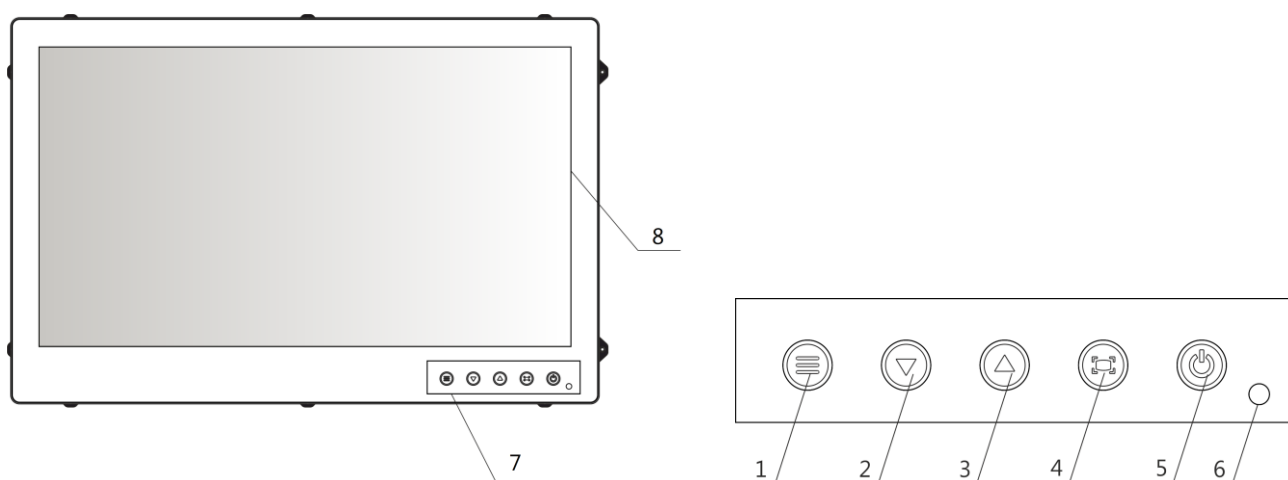

Figure 10 – Controls and indication layout on the front panel of MV-xx06, MV-xx07

Table 17 – Description of controls and indication (LEDs)

N	Name	Description
1	“Menu” button	To access the settings menu; To exit the settings menu; To exit the selected parameter
		To access the settings menu; To select a parameter in the settings menu (depending on the software version)
2	“▼”	If menu is inactive – acts as switching between channels;
3	“▲”	If menu is active – navigate through the menu and select parameters
4	Button “Automatic adjustment – Select”	If menu is inactive – automatic adjustment of the picture or switchover of video signal (VGA or DVI/HDMI); If menu is active – selects menu item or exits the menu and cancels the last selected parameter in the settings menu (depending on the software version)
5	“Power” button	To switch the Product on / off
6	Brightness LED	Screen brightness level is changed synchronously with the backlight level
7	–	Controls and indication layout
8	–	Colour display

1.4 MEASUREMENT TOOLS, INSTRUMENTS AND APPLIANCES

TS of the Product is carried out using tools and consumables represented in Table 18.

Table 18 – Number of consumables required for the TS

Name and identifier of consumables	Weight of consumables	Note
Cleaning cloth	0.10 kg	1 To clean surfaces and parts of the product – use clean cloth; 2 To clean severe contamination – use alcohol-soaked cloth
Rectified hydrolytic technical ethyl alcohol	0.01 l	To soak cloth while removing contamination
Varnish	0.05 kg	To cover surfaces of the product in case of paint coating damage
Abrasive cloth	0.06 x 0.06 m	To polish surfaces of the product in case of paint coating damage

1.5 MARKING AND SEALING

The Product has a marking plate of connectors and nameplate where a user can find a serial number, date of manufacturing, weight, protection degree, rated input voltage and power consumption.

1.6 PACKAGING

The Product are packed in a corrugated board box and inner packaging ensuring its transportation and storage at the warehouse.

Transport packaging is also used as a returnable packaging for transportation of the Product to the repair location and back. Packaging sealing is not provided.

2 INTENDED USE

2.1 OPERATIONAL CONSTRAINTS

The Product's installation site must be selected according to the operational constraints (operating temperature and protection degree).

Caution! Installation site of the Product must not be less than 1 m from a magnetic compass!

2.2 PREPARATION FOR THE PRODUCT'S OPERATION

2.2.1 Safety features

While preparing the Product to operation provide the visual check and make sure the mechanical damage is absent.

Connection of the Product to the power mains must be provided only considering input power requirements.

The Products must be switched off and grounded before connection.

The staff shall follow “The technical rules for operation of electric installation” and “Safety rules for operation of electric installation” while testing electrical circuits and insulation resistance.

2.2.2 Method of the visual check

Before switching the Product on, the staff shall:

- observe visually the cable integrity and initial position of the controls on the front panel;
- clean front panels from dust and dirt by clean soft cloth, if necessary;
- check reliable cable connections to the devices and proper grounding.

2.2.3 Switching the Product on instructions

While connecting the Product and preparing it for operation follow the steps below:

- make sure that power mains voltage conforms with input voltage requirements;
- transfer circuit breakers of main power switchboard to “OFF” position;
- connect power cable and interface cables to the Product;
- transfer circuit breakers of main power switchboard to “ON” position;
- press “Power” button on the front panel;

– adjust display brightness using brightness controls on the front panel of the Product.

Switching the Product off is carried out in the following order: switch off power supply using software tools, transfer circuit breakers of main power switchboard to “OFF” position, disconnect power cable from the Product.

2.3 USAGE OF THE PRODUCT

The Product is delivered with factory settings it is ready to be used after connection according to 2.2.

After switching the Product on, make sure that graphic data is displayed correctly and has a good quality.

To access the display’s menu press “Menu” button on the front panel. The list of function and settings is represented in Annex A (the Product’s menu may be different from installed software).

3 TECHNICAL SERVICE OF THE PRODUCT

3.1 GENERAL INSTRUCTIONS

Technical Service of the Product TS must be provided by staff, acquainted with its structure, composition and operational features.

To ensure reliable operation of the Product service personnel shall carry out all types of service:

- technical service № 1 (TS-1);
- technical service № 2 (TS-2).

TS-1, TS-2 shall be provided by staff on the equipment in operation/running.

3.2 SAFETY FEATURES

While providing the TS the staff shall follow instructions, see 4.2.

3.3 MAINTENANCE ROUTINE

The list of works for all types of the TS is given in Table 19. Maintenance routine procedure is given in the checklists (hereinafter – the CL), represented in Tables 20 – 21.

Table 19 – The list of the TS works

CL №	Name of work	TS type	
		TS-1	TS-2
1	Visual check of product	+	+
2	Product's operability test	–	+
Notes “+” – work is obligatory; “–” – work is not required.			

Table 20 – CL № 1. Visual check

To be done	Routine	Man-hours per 1 Product
Visually examine the Product	1 Check completeness and appearance of the Product; mechanical damage, paint defects must be absent; legends are to be read easily; 2 Clean all surfaces by clean cloth; 3 Remove severe contamination, parts of corrosion, oil spots: – from metal surfaces: by suds, avoiding its penetration inside the product; all surfaces clean dry by clean cloth and dry up; – from LED: by alcohol soaked cloth.	1 person 5 mins

To be done	Routine	Man-hours per 1 Product
	Do not use hard cloth, paper, glass cleaning liquids or chemicals; Do not press hard on the surface while cleaning; Do not spray liquid directly to the surface of the screen; 4 In case of varnish damage clean it with abrasive cloth, then alcohol soaked cloth, cover with varnish and let dry	
Check reliability of cable connections and grounding buses	1 Make sure that connectors and attaching screws are fastened tight, provide further fastening if needed; 2 Check integrity (no mechanical damage) of leading cables which are visible	1 person 5 mins

Table 21 – CL №2. The Product’s operability check

To be done	Routine	Man-hours per 1 Product
Check operability of the Product	1 Supply power to the product; 2 Check that screen brightness LED is working; if the picture is absent “Power” button and adjust brightness if necessary; 3 Access the Product’s menu and provide settings using buttons located on the front panel; 4 Check picture display from all possible video signal sources in turns and make sure that each port transmits the picture	1 person 15 mins

3.4 PRESERVATION

The Product and set of operational documents are stored in preserved condition in Manufacturer’s packaging boxes.

The time of representation – 5 years from the Manufacturer’s commissioning.

The representation is done in heated rooms in the same order as the preservation.

The represented Product, SPTA kit and documents are placed in package. The time of storage – 5 years.

4 INSTALLATION AND DISASSEMBLY ON THE PRODUCT

4.1 GENERAL DESCRIPTION

The Product's operability is controlled by the display brightness LED located on the front panel, and presence of image on the screen.

To test problems, see Table 22.

If trouble shooting cannot be provided, contact manufacturer's service center.

4.2 SAFETY FEATURES

Repair works must be provided by personnel, examined in occupational safety and received qualification group not lower than 3.

The Product must be grounded before repair works.

Replacing defected parts, cards and modules when power of product under repair is ON is **STRICTLY PROHIBITED**.

It is **PROHIBITED** to put a poster "DO NOT switch on! Under Operation!", when power supply switch is in OFF position.

Installation, commissioning and repair works are **PROHIBITED** in the room, where less than 2 people present.

4.3 CURRENT REPAIR

The service personnel can provide repair works as given in Table 22.

All other defects shall be carried out only by the Manufacturer's specialists or the Manufacturer's representatives.

Table 22 – Possible problems / defects and troubleshooting

Problem / defect	Possible reasons	To do
Display's image is absent, brightness LED does not glow.	No voltage supplied from the power source	Check power cable connection to the Product
		Check the fuse
		Provide the voltage
Display's image is absent, brightness LED does not glow.	No connection with signal source or low picture brightness	Check the Product's connection to the signal source
		Mare sure that correct signal source was selected using the Product's menu (see Annex A)
		Check the status of signal source
		Check that the cable has no broken or damaged (bent) connector pins
		Adjust the screen brightness using a brightness dimmer on the front panel (see Annex A) or increase brightness and contrast using the menu (see Annex A)

Problem / defect	Possible reasons	To do
The picture is displayed incorrectly (curved, blurred, doubled, etc.)	Wrong screen settings	Reset to the factory settings using the menu (see Annex A)
		Provide the settings using the menu (see Annex A)
The picture is too bright or too pale	Wrong screen settings	Reset to the factory settings using the menu (see Annex A)
		Adjust brightness by dimmer on the front panel (see Annex A) or increase brightness and contrast using the menu (see Annex A)
Picture colour fails	Wrong screen settings or connection error with the signal source	Adjust color settings using the screen menu (see Annex A)
		Check the Product's connection to the signal source
		Check that video cable has no broken or damaged (bent) connector pins

5 STORAGE

The Product must be stored in packaging inside areas complying with the required storage conditions (+5°C to + 40°C) with the concentration of dust, oil, moisture and aggressive impurities in the air within the required limits for the working areas of production facilities.

After storage or transportation of the Product below +10°C, it must be unpacked only in heated premises and left in normal climate conditions for 12 hours beforehand.

6 TRANSPORTATION

The Product must be transported in the Manufacturer's transportation package in closed means of transport.

Types of shipment:

- motor vehicle and railroad transportation in closed means of transport (covered cars, multipurpose containers);
- air transportation (in sealed and heated compartments);
- sea transportation (in dry service premises).

The Product must be transported in compliance with transportation rules applicable for each means of transport.

During loading / unloading operations and transportation, the requirements indicated on warning labels on the boxes / packaging must be observed, and no impacts are permitted since they can affect the safety and performance of the Product.

Inside the means of transport, the packed product must be firmly secured / fastened.

7 DISPOSAL

New equipment, the parts of the Product damaged during operation, and any overage equipment must not be disposed as standard household wastes, since they contain the materials suitable for re-use.

Decommissioned and non-used components of the Product must be delivered to a special waste disposal center licensed by local authorities. You can also send an overage equipment / unit to the manufacturer for its further disposal.

Proper disposal of Product components allows avoiding possible negative environmental and health impacts, and it also allows for proper restoration of components with substantial energy and resources saving.

During operation and upon completion of its service life, the equipment is not hazardous for health and environment

This unit must be disposed according to the rules applied to electronic devices



Any products marked with a crossed trash bin must be disposed separately from standard house-hold wastes

8 WARRANTY

The Manufacturer is under warranty obligations in case of correct System exploitation according to the OM. In case of incorrect operation or service damage claims are not considered by the Manufacturer.

More information about warranty terms you can find on the official site of “NPK Morsvyazavtomatica” LLC, section Support.

Address and contacts of the Manufacturer's service centre:

“NPK Morsvyazavtomatica” LLC

26E, Kibalchicha str., 192174, St Petersburg, Russia

Tel.: + 7 (812) 602-02-64, 8-800-100-67-19

fax: +7 (812) 362-76-36

e-mail: service@unicont.com

ANNEX A DESCRIPTION OF THE PRODUCT'S MENU

The Product menu is available in one or two variants. The first variant of the menu is shown in Figures A.1–A.6, the second variant – in Figures A.7–A.11. Description of the Product menu see in Tables A.1–A.11.

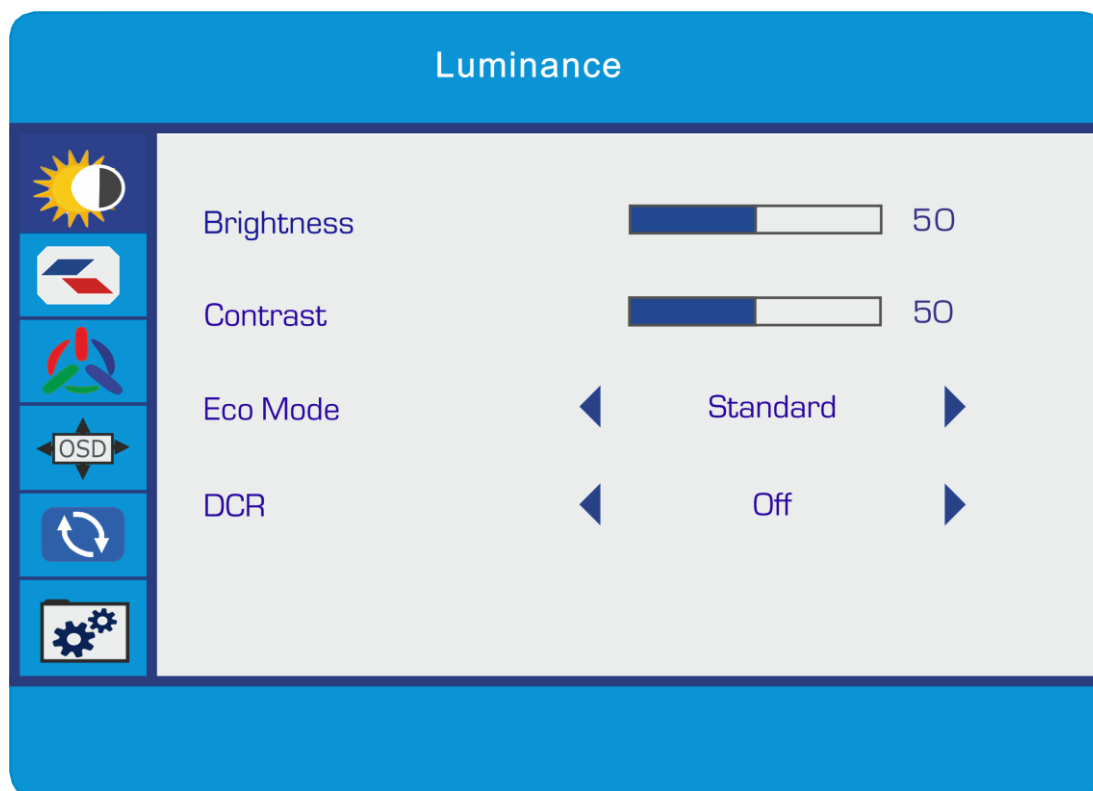

Figure A.1 – Luminance

Table A.1 – Luminance

Name of the menu item	Configuration parameters
Brightness	Brightness adjustment, range 0 to 100, with step 1
Contrast	Contrast adjustment, range 0 to 100, with step 1
Eco mode	Standard Movie
DCR	Off On



Figure A.2 – Image setup

Table A.2 – Image setup

Name of the menu item	Configuration parameters
H.Position	H.Position adjustment, range 0 to 100, with step 5
V.Position	V.Position adjustment, range 0 to 100, with step 5
Clock	Clock adjustment, range 0 to 100, with step 5
Phase	Phase adjustment, range 0 to 100, with step 5
ImageRatio	Wide 4:3
* There may be changes depending on the version of the controller.	

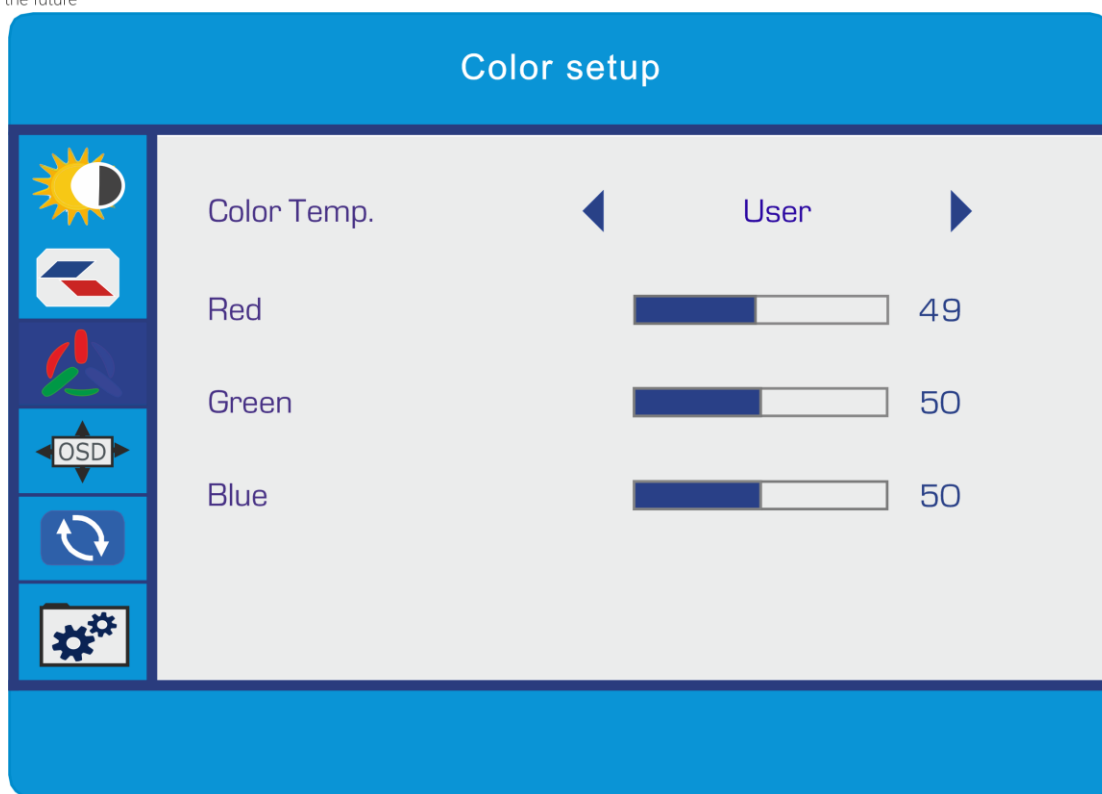

Figure A.3 – Color setup

Table A.3 – Color setup

Name of the menu item	Configuration parameters
Color Temp.	User Warm Normal Cool sRGB
Red	Red adjustment, range 0 to 100, with step 1
Gree	Green adjustment, range 0 to 100, with step 1
Blue	Blue adjustment, range 0 to 100, with step 1
* The colours red, green, blue are involved only when using the “user” parameter.	

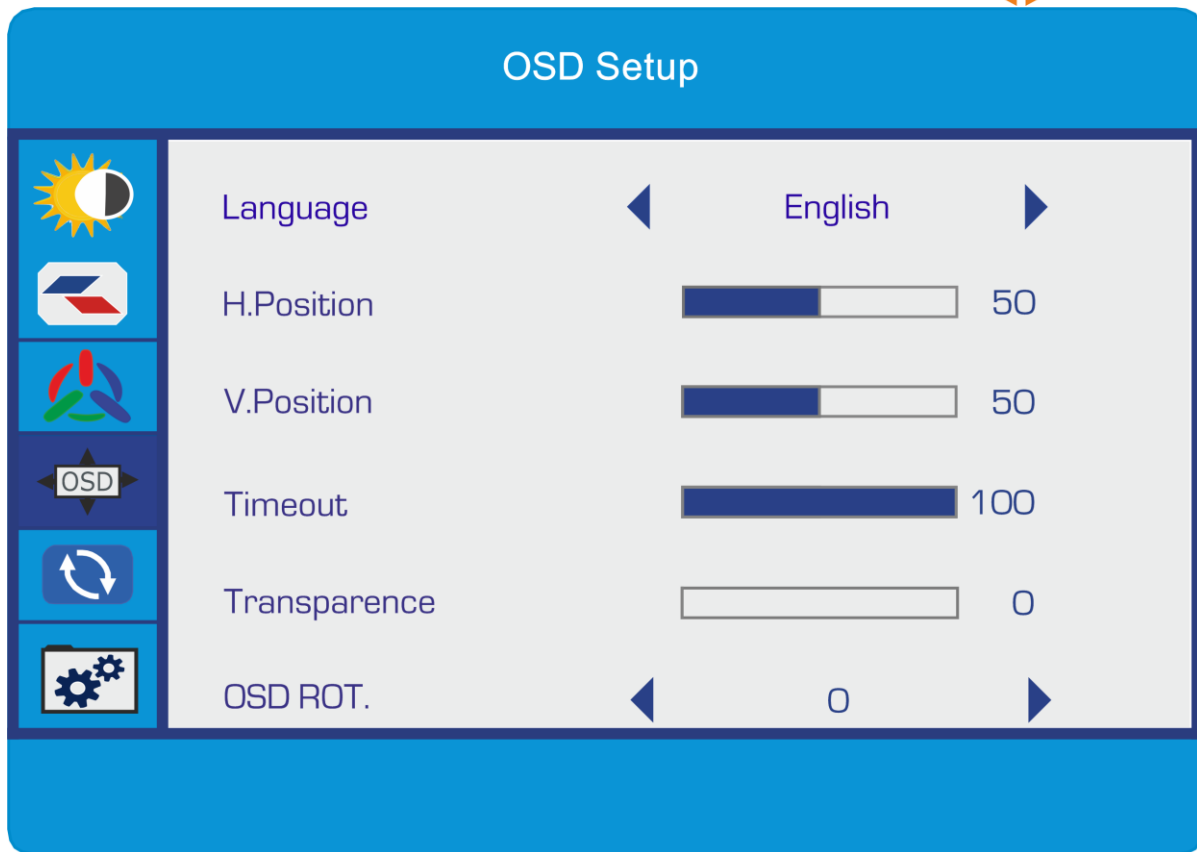

Figure A.4 – OSD Setup

Table A.4 – OSD Setup

Name of the menu item	Configuration parameters
Language	English Russian Chinese etc.
H.Position	H.Position adjustment, range 0 to 100, with step 5
V.Position	V.Position adjustment, range 0 to 100, with step 5
Timeout	Timeout adjustment, range 5 to 100, with step 5
Transparence	Transparence adjustment, range 0 to 100, with step 20
OSD ROT.	0 90 180 270

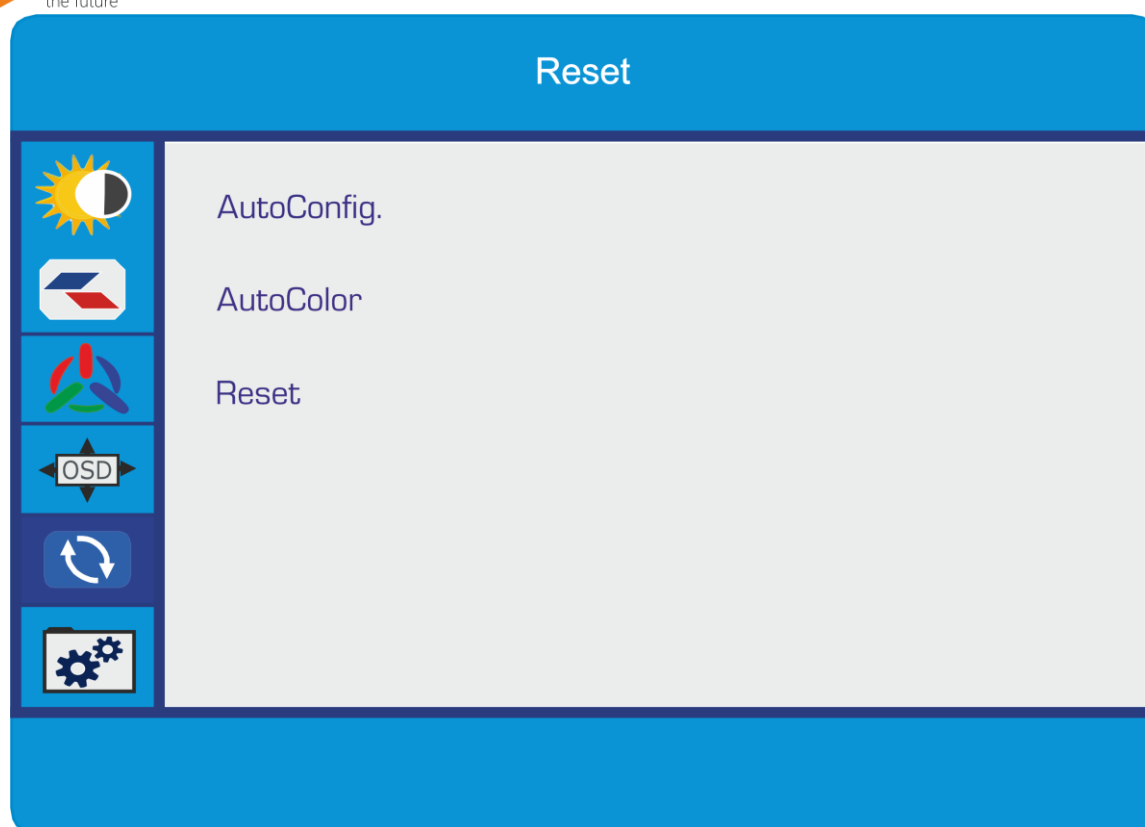

Figure A.5 – Reset

Table A.5 – Reset

Name of the menu item	Configuration parameters
Auto Config.	UNUSED
Auto Color	UNUSED
Reset*	–
* Only works with VGA. Does not work with HDMI, DVI.	



Figure A.6 – Extra

Table A.6 – Extra

Name of the menu item	Configuration parameters
Input Select*	VGA HDMI DVI
Mute	Off On
Volume	Volume adjustment, range 0 to 100, with step 1
<p>* Audio is only transmitted through an HDMI source. By default, at initial switch-on, the sound will be transmitted through the HDMI cable if it is connected. To transmit audio via the audio jack (3.5jack or PC10TB), you must select this source in the personal computer used.</p>	

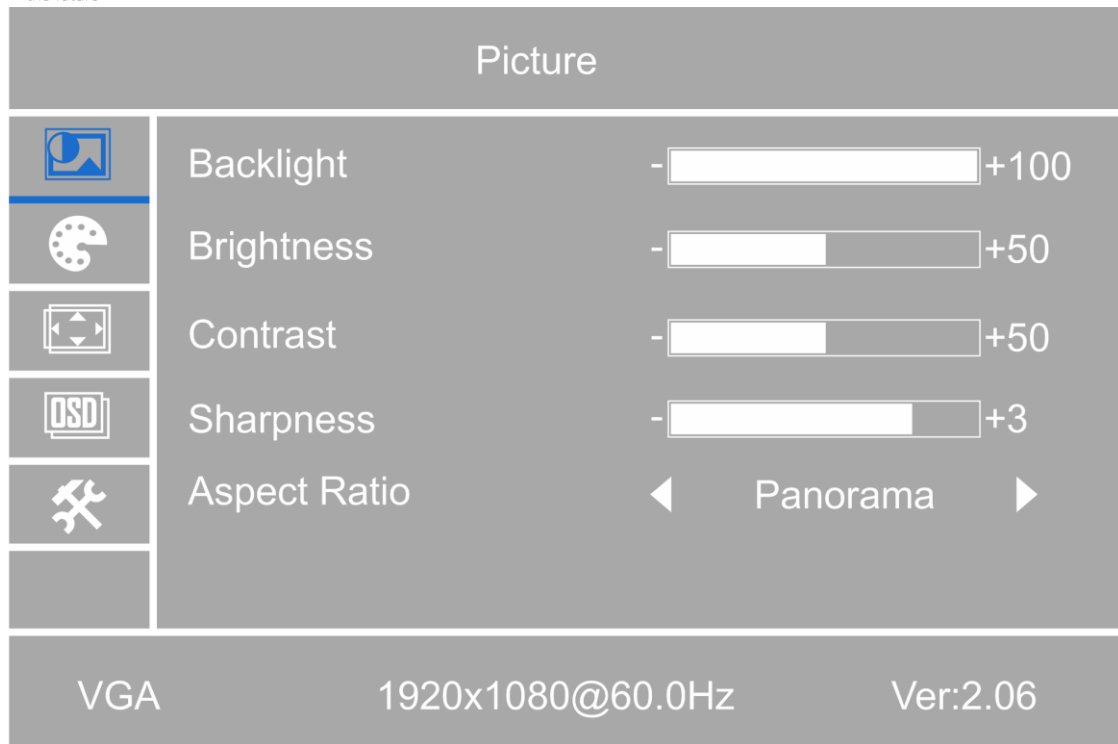

Figure A.7 – Picture

Table A.7 – Picture

Name of the menu item	Configuration parameters
Backlight	Backlight adjustment, range 0 to 100, with step 1
Brightness	Brightness adjustment, range 0 to 100, with step 1
Contrast	Contrast adjustment, range 0 to 100, with step 1
Sharpness	Sharpness adjustment, range 0 to 4, with step 1
Aspect Ratio	Panorama 4:3

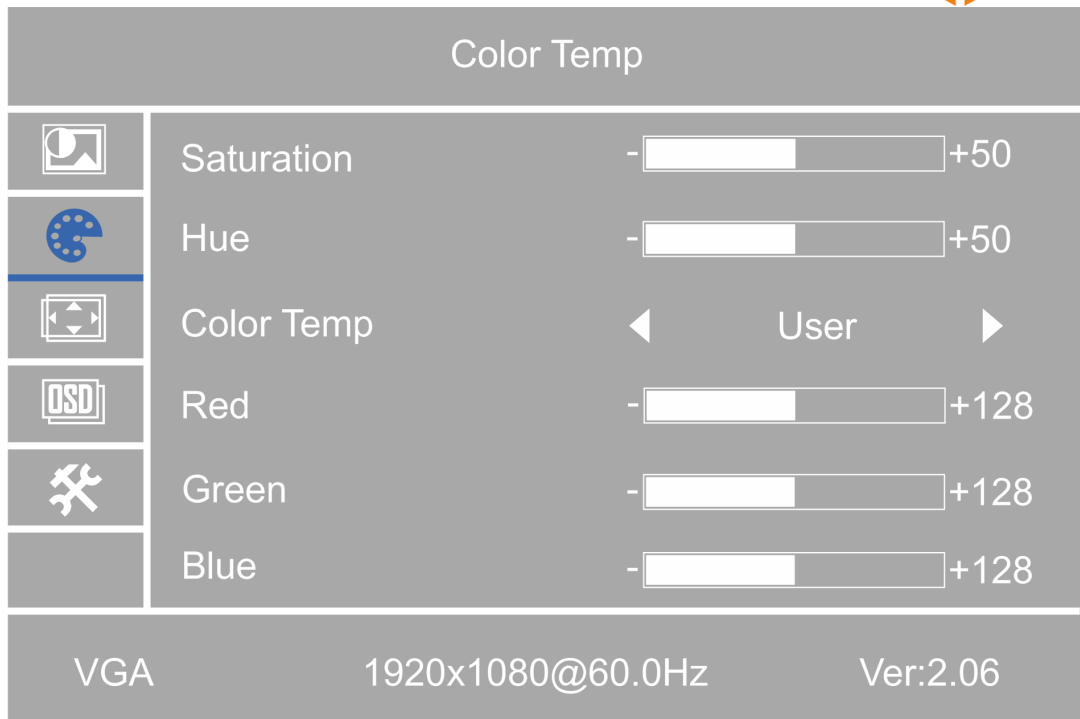

Figure A.8 – Color Temp

Table A.8 – Color Temp

Name of the menu item	Configuration parameters
Saturation	Saturation adjustment, range 0 to 100, with step 1
Hue	Hue adjustment, range 0 to 100, with step 1
Color Temp	User 5800 K 6500 K 7500 K 9300 K
Red	Red adjustment, range 0 to 255, with step 1
Green	Green adjustment, range 0 to 255, with step 1
Blue	Blue adjustment, range 0 to 255, with step 1

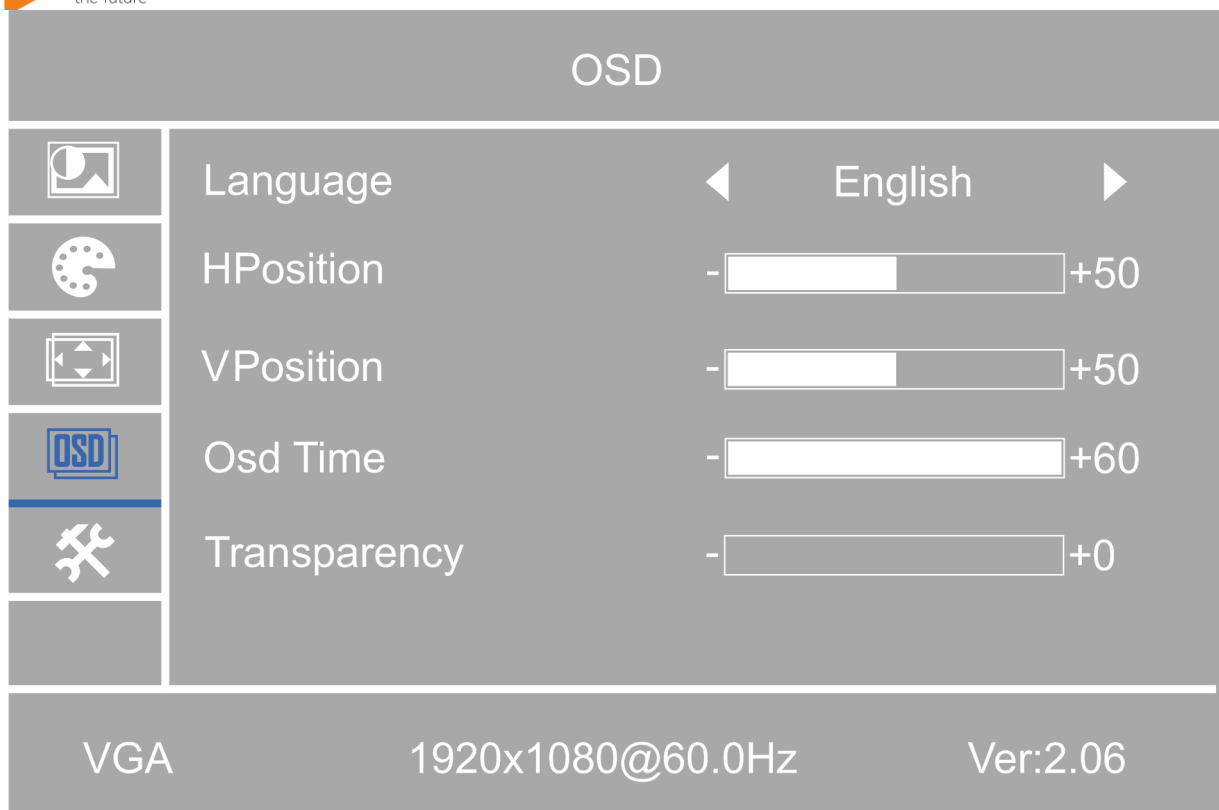

Figure A.9 – OSD

Table A.9 – OSD

Name of the menu item	Configuration parameters
Language	Russian English Chinese
HPosition	HPosition adjustment, range 0 to 100, with step 1
VPosition	VPosition adjustment, range 0 to 100, with step 1
Osd Time	Osd Time adjustment, range 10 to 60, with step 1
Transparency	Green adjustment, range 0 to 100, with step 1

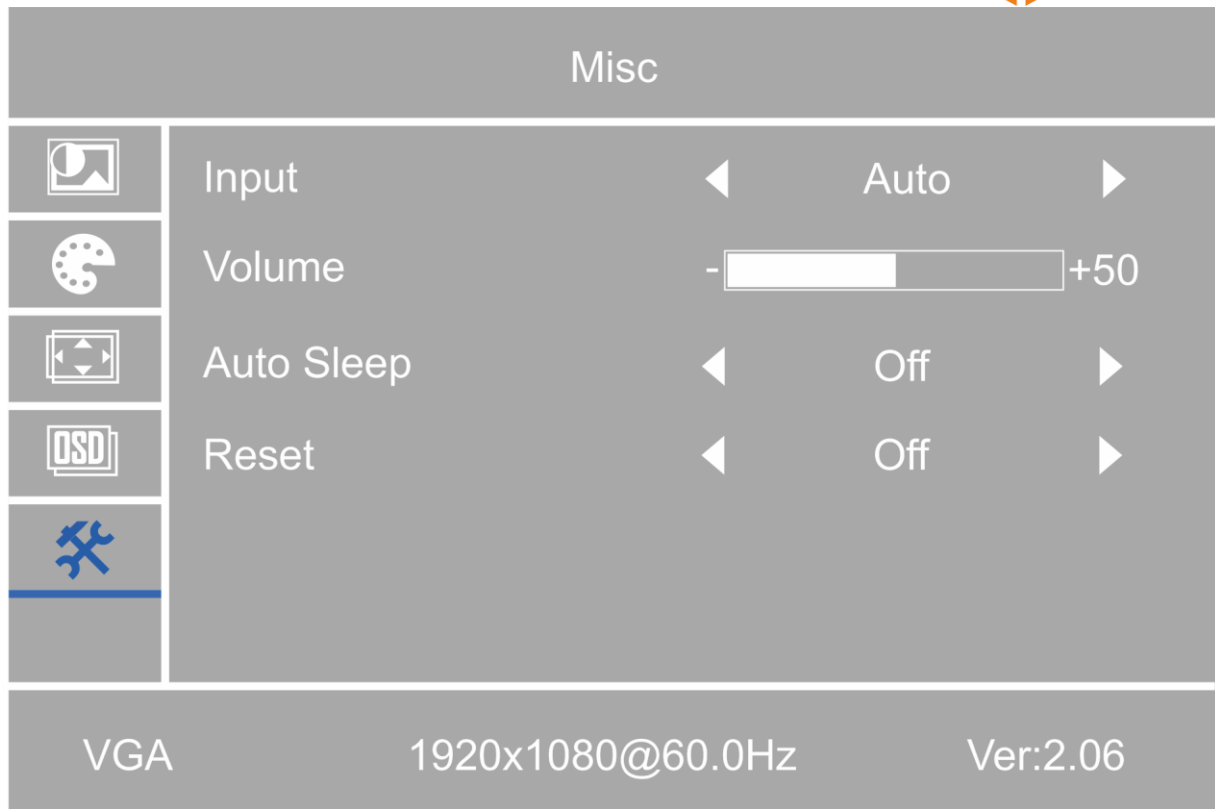

Figure A.10 – Misc

Table A.10 – Misc

Name of the menu item	Configuration parameters
Input*	Auto VGA D1-DVI D3-HDMI
Volume	Volume adjustment, range 0 to 100, with step 1
Auto Sleep	Off 10S 20S 30S
Reset	Off On

* Audio playback (if there are speakers) is performed by selecting the audio source in the settings of the electronic computer.

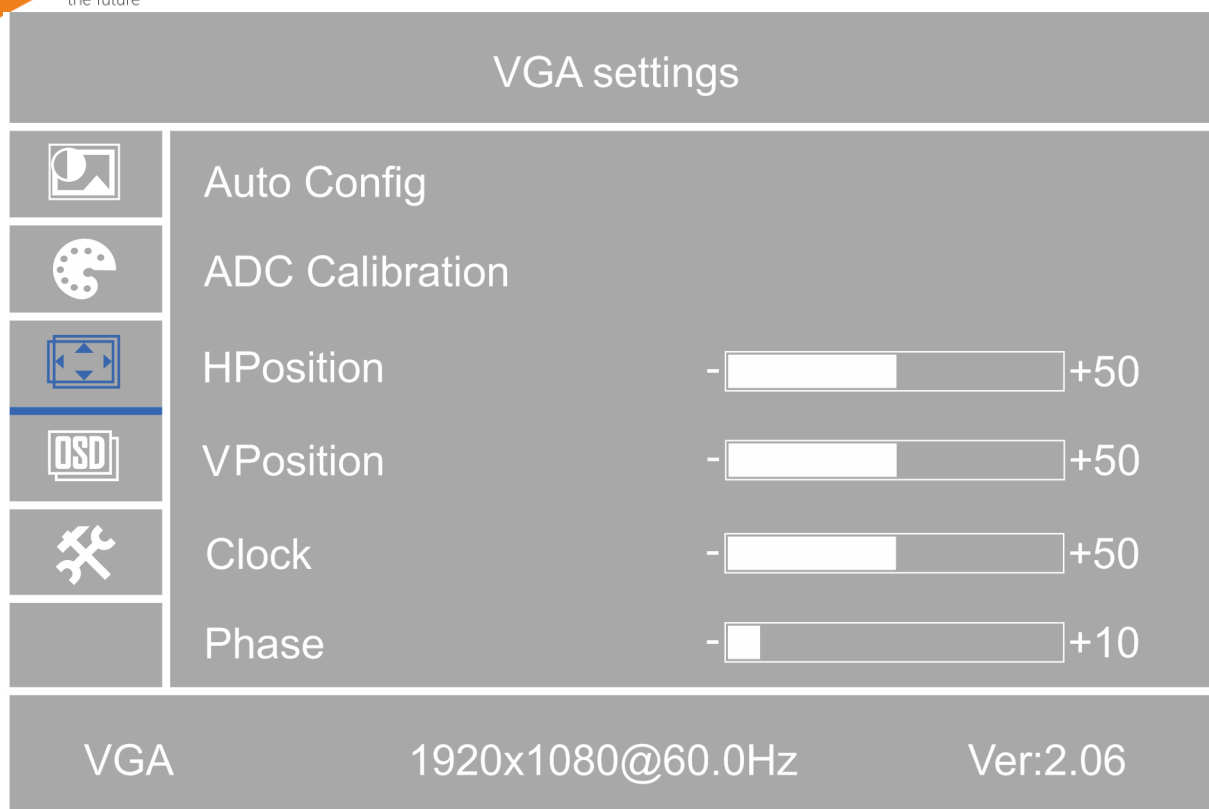

Figure A.11 – VGA settings

Table A.11 – VGA settings*

Name of the menu item	Configuration parameters
Auto Config	UNUSED
ADC Calibration	UNUSED
HPosition	HPosition adjustment, range 0 to 100, with step 1
VPosition	VPosition adjustment, range 0 to 100, with step 1
Clock	Clock adjustment, range 0 to 100, with step 5
Phase	Phase adjustment, range 0 to 100, with step 5
* Used only when VGA is connected. Does not work with HDMI, DVI.	